

ProArc[®]

E·Z·Arc System

WELDING POSITIONERS

TURNING ROLLS



E.Z.Arc system is a combination of positioners and turning rolls in bench design. You have a wide choice of components to create great flexibility in your automatic welding system. You are also able to change components easily to minimize the setup time. The special capability of E.Z.Arc system will help you produce high quality circumferential welds and provide the advantage of fast pay-back, safety and less worker fatigue, which will exactly meet your needs.

Features

- CE conformity
- Standard 38.5 mm ϕ through-hole for gas purge
- Remote foot switch - Run / Stop control
- All units are high frequency protected
- Additional speed ranges available on special order
- U-Type is a special design for 0~90° circumferential welding and can be used for weldments size up to max. 300 mm ϕ with 300 mm L.

How to order

Example:

PT-101 - A - L - 12

Model No.	Types:	Rail length
PT-101	A L - Lathe type	06
PT-102	B R - Roll type	12
PT-201	C S - Standard type	15
PT-202	D U - Universal type	18

E.Z.Arc Components

Fig. No.	Part No.	Description / Specification	- Type -				
			S	R	L	U	
1	1106	Base rail, 600 mm long	1*				
	1112	Base rail, 1200 mm long		1*	1*		
	1115	Base rail, 1500 mm long					
	1118	Base rail, 1800 mm long					
	4095	Main bracket					1
2	2050	Mounting rail, 500 mm long	1	1	1		
	2065	Mounting rail, 650 mm long					1
3	2110	End bracket	1	1	1		
	2280	End bracket					1
4	3075	Column tube, 750 mm long	1	1	1		
	3064	90° column tube, 600 mm x 400 mm					1
5	2005	Support bracket	1	1	1		
	2004	Support bracket					1
6	2054	Cross bracket	1	1	1		
	2044	Cross bracket					1
7	3040	Boom tube with mounting pad, 400 mm long	1	1	1	1	
8	SL-050	Slide, 50 mm stroke	2	2	2	2	
	SL-075	Slide, 75 mm stroke					
9	AH-035	Any angle holder, ϕ 15-35 mm					
	VH-035	V-Block torch holder, ϕ 15-35 mm	1	1	1	1	
10	IS-300	Idler stand, ϕ 30-300 mm				1	
11	TS-075	Tailstock, 75 mm stroke					1
	TS-075S	Tailstock, 75 mm stroke					1
Options:							
12	PG-150	3-Jaw chuck, OD 4-150 mm (Centering adaptor included)					
	PG-450L	3-Jaw chuck, OD 4-450 mm (Centering adaptor included)					
	PG-500	3-Jaw chuck, OD 4-500 mm (Centering adaptor included)					
13	TA-100	Pneumatic torch actuator, 100 mm stroke					
	TL-100	Pneumatic torch lift, 22.5° lift angle					
14	CB-001	Standard control box					
	CB-001D	Digital control box					
	CB-002	Sequencer, start delay / overlap controlled by original sensor setting					
	CB-002D	Digital sequencer, original sensor control					
	CB-007	Sequencer, intergrate pneumatic tailstock, torch lift and table rotation in one process					
	CB-001V	Variable speed remote control box					
15	1712W	Welding table with wheels, 1200 mm x 600 mm					
	1715W	Welding table with wheels, 1500 mm x 600 mm					
	1718W	Welding table with wheels, 1800 mm x 600 mm					
16	10-613	Jig adaptors , 3 x 6.5 mm ϕ (P.C.D. 50 mm) mounting hole with a 38.5 mm ϕ x 5 mm (D) pilot hole					

* Standard length, other length are available.



▪ PT-101



▪ PT-102



▪ PT-201



▪ PT-202

▪ S-type



▪ R-type

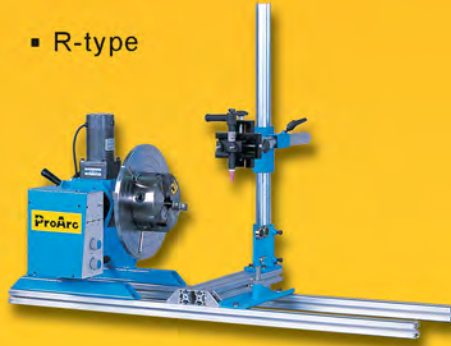

▪ L-type

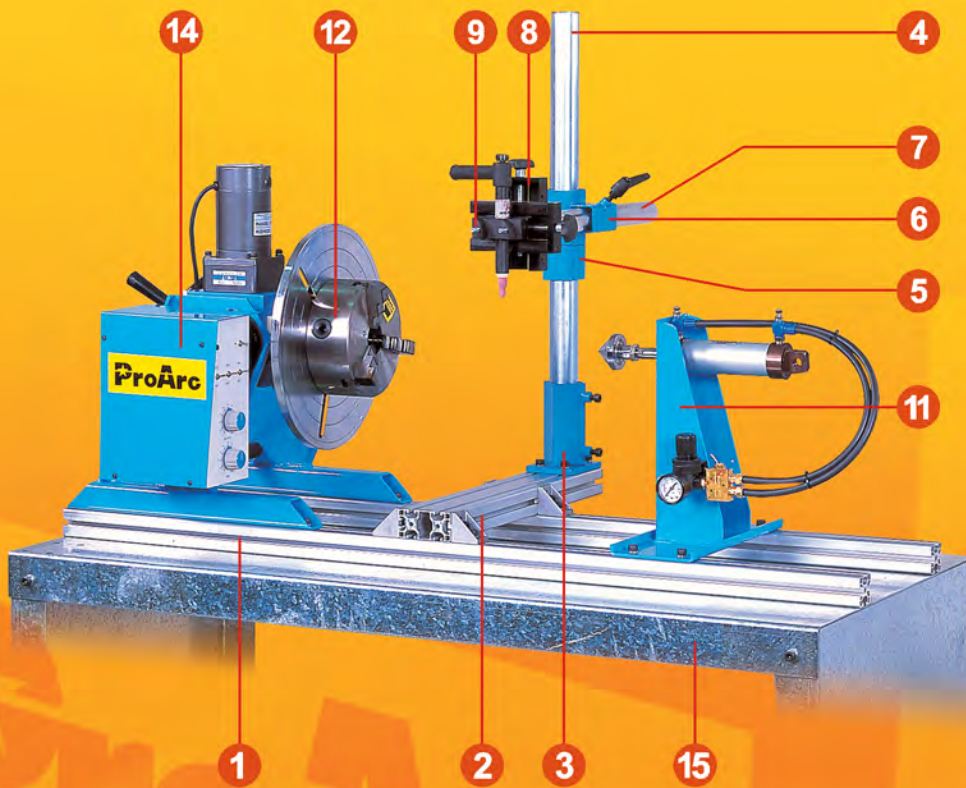
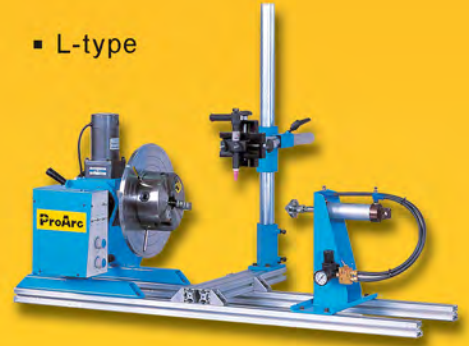

▪ U-type

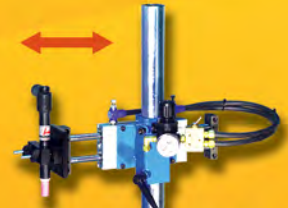

▪ TA-100



▪ TL-100



8. SL-050



9. AH-035 / VH-035



10. IS-300



12. PG-150 / 450L / 500



14. CB-001D / 002 / 007



14. CB-001V / CB-001DV VSFC-1K



15. 1712W / 1715W / 1718W



16. 10-613

Specifications



▪ PT-101

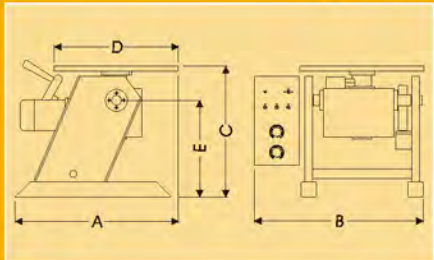

Model	Unit	PT-101	PT-201
Power input	~	1 phase 110 / 220V 50 / 60Hz	
Capacity (horizontal/vertical)	kg	100 / 60	200 / 130
Rated center of gravity	mm	-	
Rated eccentricity	mm	A:80 B:45 C:30 D:22	A:60 B:35 C:22 D:17
Table dimension (D)	mm	320	
Rotation speed	rpm	A:0.15-4 B:0.3-8 C:0.4-12 D:0.55-16	
Spindle thru hole	mm	38.5	
Table slot bolt size	-	M10	
Earthing	amp	200 @ 100%, 300 @ 40%	
Rotation motor	hp	1 / 20	1 / 12
Tilt range	deg	0-120	0-120
Welding timer	sec	0-60	
Overall length (A)	mm	420	
Overall width (B)	mm	435	
Overall height (C)	mm	340	
Center to floor (E)	mm	250	
Net weight	kg	34	36
Gross weight	kg	36	38
Dimension (L*W*H)	mm	PT: 500*390*380 CB:390*340*170	

New



▪ TR-0102 Digital Turning Rolls



▪ TR-3504

Model	Unit	TR-0100/0102	TR-3504
Power input	~	1ph 110/220V 50/60Hz	1ph 220V 50/60Hz
Turning capacity	kg	1000	3500
Load capacity (Drive + Idler)	kg	1000	3500
Diameter range (F)	mm	20-800	9-1400
Speed range	mm/min	80-1600	60-1200
Rotation motor	hp	1/12	1/2
Roller dia. (D)	mm	200	
Roller width (E)	mm	50	100
Roller type	-	PU	
Overall length (A) (Drive / Idler)	mm	320 / 160	425 / 280
Overall width (B) (Drive / Idler)	mm	542 / 450	780 / 700
Overall height (C)	mm	335	520
Net weight (Drive / Idler)	kg	37 / 17	110 / 55
Gross weight	kg	58	185

Specification are subject to change without prior notice.

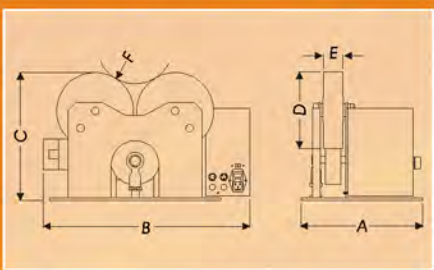

ProArc builds a full line of improved welding positioners from 100kg to 20,000kg and turning rolls from 1,000kg to 120,000kg for your needs. On special requirements, ProArc can supply custom design equipment for your job

NEW

Positioners

▶▶ *PT series*



■ PT-102



■ PT-202

ProArc brand new precision digital positioners provide steel fabrication shops to position the jobs for 'downhand' position in the shortest possible time without the use of cranes and manpower.

Features

- Precision speed controls suitable for automation application
- Digital display meter on the control box
- 5 digits LED RPM display meter
- Variable speed models: A for 0.15~5rpm, B for 0.3~10rpm, C for 0.4~15rpm and additional speed ranges available on special order
- Encoder mounted onto PMDC motor
- Outstanding speed range: Adjusting ratio 1:37.5
- Allows for input voltage hookup 100~240VAC without manual linking
- Standard 38.5mm diameter through-hole for gas purge
- All units are high frequency protected
- E-stop button
- Remote foot switch - Run / Stop control
- Compatible with ProArc E.Z.Arc automatic welding system
- CE conformity

Specifications

Model	Unit	PT-102	PT-202
Power input	~	1 phase 100-240V 50 / 60Hz	
Capacity (horizontal/vertical)	kg	100 / 60	200 / 130
Rated center of gravity	mm		
Rated eccentricity	mm	A: 180 B: 90 C: 60	A: 84 B: 42 C: 28
Table dimension (D)	mm	320	
Rotation speed	rpm	A: 0.15-5 B: 0.3-10 C: 0.4-15	
Spindle thru hole	mm	38.5	
Table slot bolt size	-	M10	
Earthing	amp	200A @ 100%, 300A @ 40%	
Rotation motor	hp	1 / 12	
Tilt range	deg	0-120	
Welding timer	sec	0-60	
Overall length (A)	mm	420	
Overall width (B)	mm	435	
Overall height (C)	mm	340	
Center to floor (E)	mm	250	
Net weight	kg	35	37
Gross weight	kg	38	40
Dimension (L*W*H)	mm	PT: 500*390*380 CB:390*340*170	

Dimensions

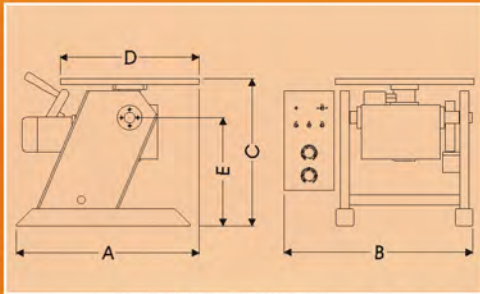

Controller model selection

CB-001D

Welding speed control
Welding timer control
LED RPM display meter
E-stop button

CB-002D

Welding speed control
Start delay timer control
Overlap timer control
LED RPM display meter
E-stop button

Options

- Fast / Slow footswitch
- Welding grounds
- Grippers



▪ CB-001D



▪ CB-002D

ProArc

UNITED PROARC CORPORATION

No.3 Gungye 10th Road, Pingjen Ind. Park, Pingjen City, Taoyuan 324, Taiwan
Tel: 886-3-4696600 Fax: 886-3-4694499 Http://www.proarc.com.tw E-mail:sales@proarc.com.tw